

N	---	AZUL
T	---	MARRON
S	---	GRIS
R	---	NEGRO
⏚	---	AMARILLO/VERDE

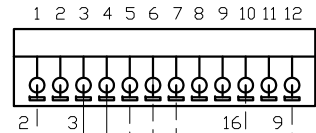

REGLETA KONEX  
12 CONEXIONES

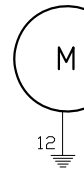
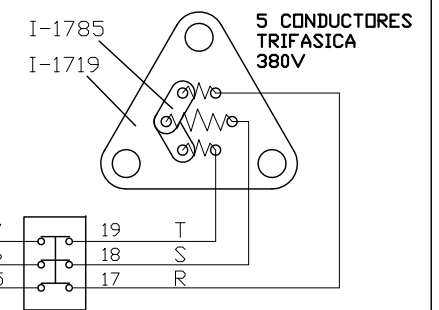
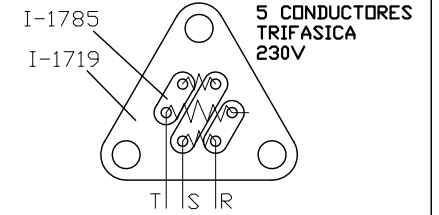
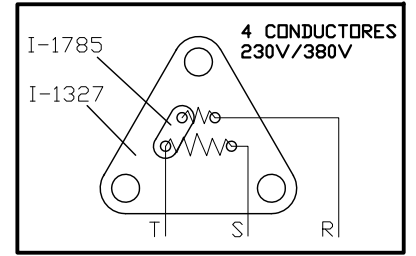

PRESTATO SIRAI I-1990

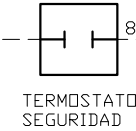

CONTACTOR I-1747

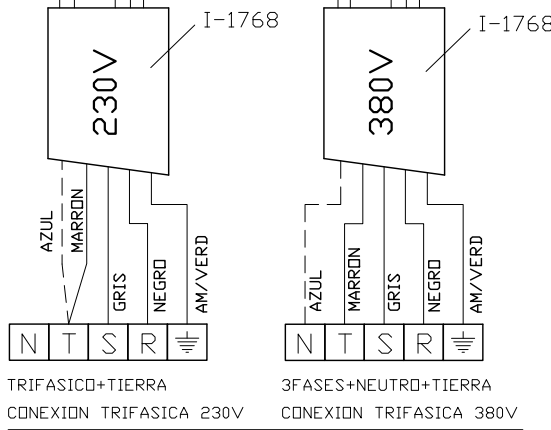
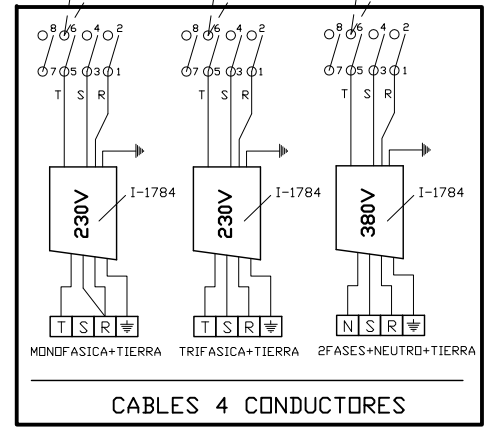
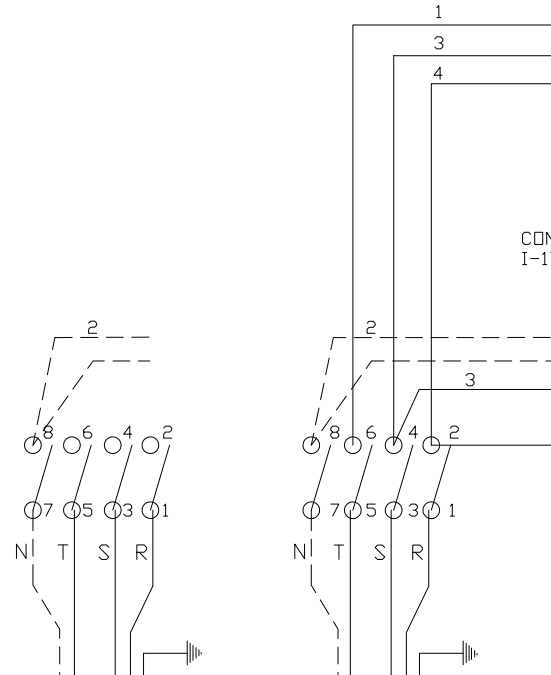
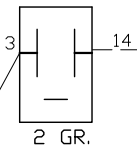
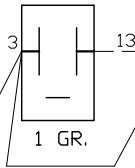
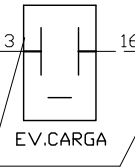

CABLES 5 CONDUCTORES

CABLES 4 CONDUCTORES

MODIFICACIÓN / MODIFICATION		DATE	V
ACABADOS GENERALES		SUAUZAR ARISTAS MÁXIMO ch/R 0.3	TOLERANCIAS GENERALES ± 0.1
MATERIAL	VARIOS	E	MODIFICACIÓN
ACABADO	VARIOS	S/E	FECHA
DENOMINACIÓN		ESQUEMA BARISTA PRO 2GR	
CONJUNTO		BARISTA	
CÓDIGO		FECHA: 19/03/12	VERSIÓN
ascaso		I-1788	
		1	
PROYECTADO	DIBUJADO	APROBADO	
J.A.	PCB	J.A.	

N	---	AZUL
T	—	MARRON
S	—	GRIS
R	—	NEGRO
⏚	—	AMARILLO/VERDE

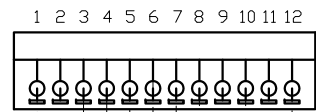
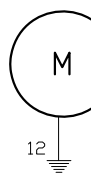

REGLETA KONEX  
12 CONEXIONES

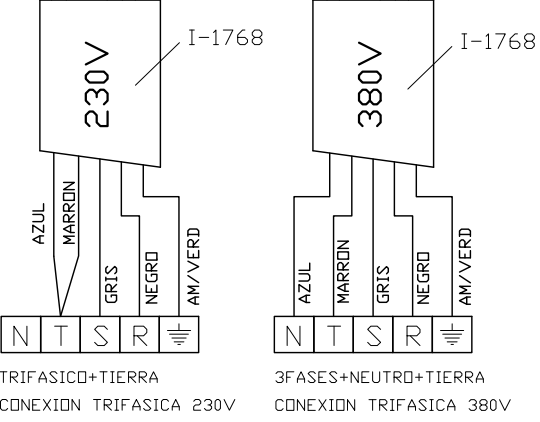
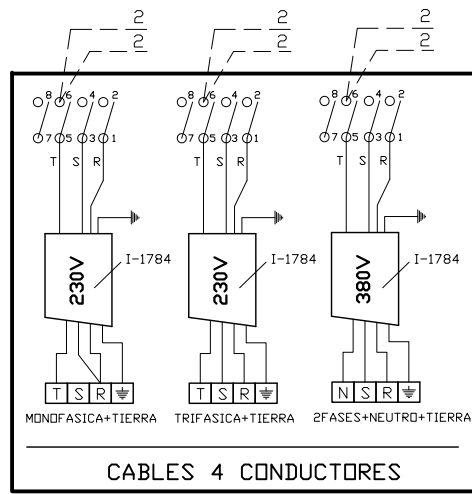
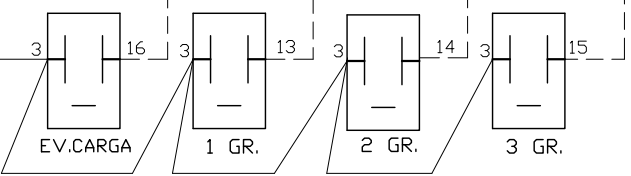
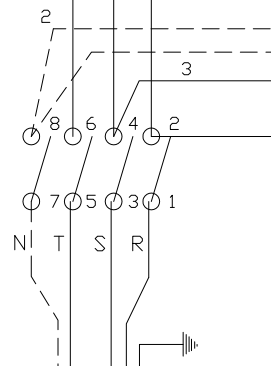
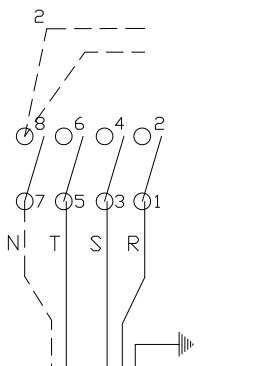
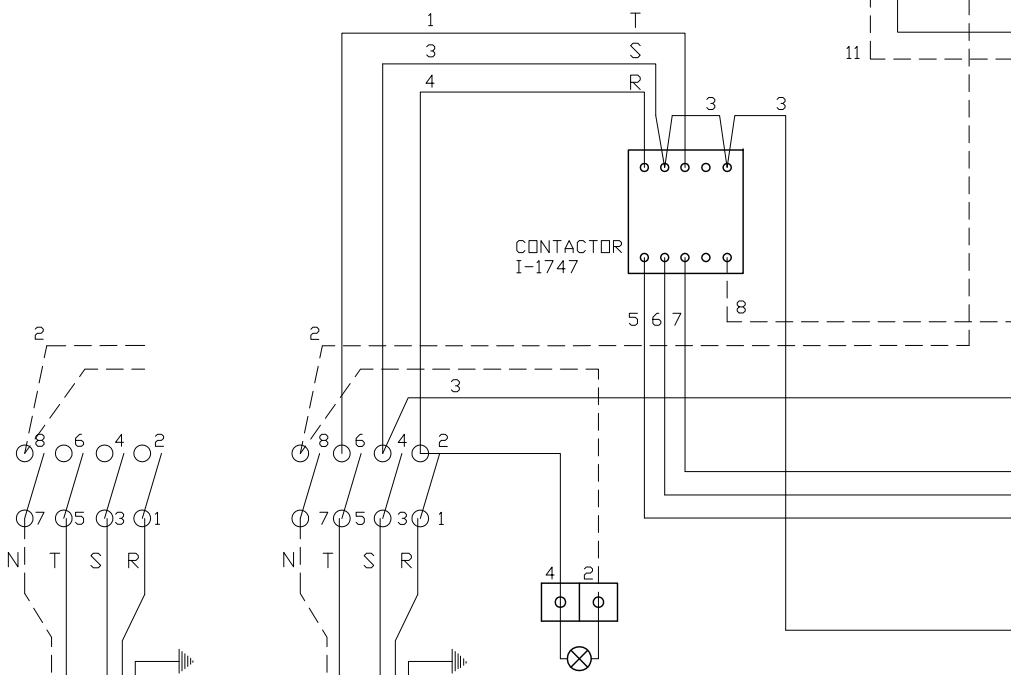
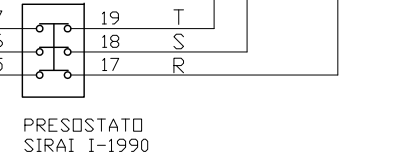
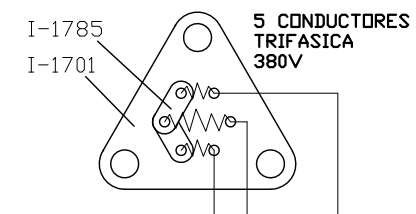
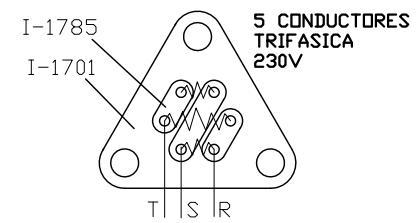
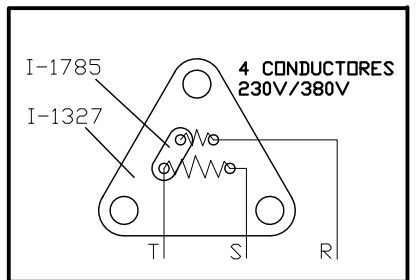

CABLES 5 CONDUCTORES

CABLES 4 CONDUCTORES

MODIFICACIÓN / MODIFICATION		DATE	V
ACABADOS GENERALES		SUAIVIZAR ARISTAS MÁXIMO ch/R 0.3	TOLERANCIAS GENERALES ± 0.1
MATERIAL	VARIOS	E	MODIFICACIÓN
ACABADO	VARIOS	S/E	FECHA
		DENOMINACIÓN	
		ESQUEMA BARISTA 3GR	
		CONJUNTO	
		BARISTA	
		CÓDIGO	FECHA: 19/03/12
		VERSIÓN	
		I-1790	
		1	
PROYECTADO	DIBUJADO	APROBADO	
J.A.	PCB	J.A.	

ascaso